

**PROMOTING ACADEMIA-INDUSTRY ALLIANCES FOR R&D
THROUGH COLLABORATIVE AND OPEN INNOVATION PLATFORM**
AI4R&D

Co-funded by the
Erasmus+ Programme
of the European Union



AI4R&D

– PRVI NACIONALNI SASTANAK –
GRAĐEVINSKI FAKULTET, SALA BURENCE, ČETVRTAK 07.03.2019. u 9:00



www.gf.unsa.ba gfsa@gf.unsa.ba

Patriotske lige 30, 71000 Sarajevo Bosnia and Herzegovina

Tel: +387 33 278 400 Fax: +387 33 200 158



O PROJEKTU

Promocija saveza akademske zajednice i privrede za istraživanje i razvoj kroz suradnju i otvorenu inovacijsku platformu

Referentni broj projekta: 598.719-EPP-1-2018-1-MK-EPPKA2-CBHE-JP

Program: Erasmus +

Namjera: Saradnja u inovacijama i razmjenu dobrih praksi

Početni datum: 15. studenog 2018

Trajanje: 36 mjeseci

Web: <http://all4rd.net/>



PARTNERI

- [Ss. Cyril and Methodius University in Skopje](#), Macedonia (UKIM), Faculty of Civil Engineering
- Institute for Research in Civil Engineering , Environment and Energy, Skopje, Macedonia (IECE)
- Ruhr University of Bochum, Germany (RUB)
- Vaasan Yliopisto, Vaasa, Finland (UVA)
- University of Sarajevo, Bosnia and Herzegovina (UNSA)





PARTNERI

- Dzemal Bijedic University of Mostar, Bosnia and Herzegovina (UNMO)
- National Polytechnic University of Armenia Foundation (NPUA)
- National University Architecture and Construction of Armenia (NUACA)
- Yerevan Telecommunication Research Institute, Armenia (YeTRI)
- Institute for Informatics and Automation Problems of the National Academy of Sciences of the Republic of Armenia (IIAP)





PARTNERI

- World University Service – Austrian Committee (WUS Austria)
- Winner Project, Sarajevo, Bosnia and Herzegovina (WP)
- HP Investing Mostar, Bosnia and Herzegovina (HP)





CILJEVI

Ubrzati istraživanje, inovacije, prijenos znanja i tehnologija u Bosni i Hercegovini i Armeniji kroz jačanje strateških saveza između akademske zajednice i privrede.

Jačati postojeće i uspostavljati nove univerzitetske strukture za istraživanje i razvoj zajedno s privredom.

Biti partneri u područjima stvaranja i prijenosa znanja, istraživanja i inovacija, komercijalizacije rezultata istraživanja i razvoja.



CILJEVI

Razviti metodologiju za saradnju i otvorene inovacije te uspostaviti internetsku platformu s naglaskom na prijenosu znanja, inovacijama i potencijalima za umrežavanje.

Testirati i pregledati model saradnje između univerziteta i privrede kroz pilot projekte.

Unaprijediti razvoj karijere i zapošljivost studenata i bivših studenata nudeći nove i inovativne mogućnosti u istraživanju i obrazovanju.



POTENCIJALNI KORISNICI PROJEKTA

Akademske i istraživačke institucije

Privredni partneri (privatna poduzeća, posebno oni koji imaju snažan potencijal za istraživanje i inovacije)

Studenti i alumni

Vladine agencije, ministarstva, javna poduzeća, poslovne i profesionalne udruge

Investicijske agencije i fondovi trećih strana



POZVANI

PROIZVOĐAČI	PROJEKTANTI	INSTITUCIJE	NAUKA	IZVOĐAČI
<ul style="list-style-type: none"> • ARCELOR MITTAL • HEIDELBERGCEMENT • MC - BAUCHEMIE • PERCOM • ROEFIX • TBG BH 	<ul style="list-style-type: none"> • ADS Studio • ARKUS • BP • BPC • CALYPSO • CANBOS • DIVEL • EMNA • EUROENGINEER • FABING • GRUPA ARH • IPSA • STUDIO NONSTOP • STUDIO ZEC • T & E • TRASA 	<ul style="list-style-type: none"> • CESTE FBIH • FEDERALNO MINISTARSTVO PROSTORNOG UREĐENJA • INSTITUT ZA STANDARDIZACIJU • MINISTARSTVO PROSTORNOG UREĐENJA, GRAĐENJA I ZAŠTITE OKOLIŠA KS • UNDPBIH • VANJSKOTRGOVINSKA KOMORA • ZAVOD ZA IZGRADNJU KANTONA SARAJEVO • ZAVOD ZA PLANIRANJE RAZVOJA KANTONA SARAJEVO 	<ul style="list-style-type: none"> • UNMO • UNSA • PTF Zenica 	<ul style="list-style-type: none"> • ANS Drive • BUTMIR • DZEKOS • EUROASFALT • OSDIN • ROLLING • TERMOBETON • VELBOS

i svi ostali zainteresovani su dobro došli !!!



REZULTATI PROJEKTA

Uspostavljanja specifične, široke, interaktivne, sveobuhvatne veze između akademske zajednice i privrede

Kroz saradnju osigurati vitalni ljudski kapital, s vještinama i kompetencijama koje su potrebne danas

Nadopunjavati uzajamna iskustva

Zajedno, u saradnji nauke i privrede, pomjeriti granice znanja i postati pokretač inovacija i privrednog rasta



AKTIVNOSTI

Skoplje, januar 2019

- prezentacija programa,
- predstavljanje učesnika,
- menadžerski sastanak.

Zaključci:

- organizovati nacionalni sastanak,
- pristupiti anketiranju pozvanih.

WPI-Kick Off Meeting-Skopje





SLIJEDI

WP2-Workshop-Vaasa



 May 13, 2019–May 15, 2019

 Vaasa University

Materials will be published soon.

[Read more](#)



UNIVERZITET SARAJEVO

- Začet 1573.
- Osnovan 1949.
- Trenutno studira 28,000 studenata
- 160,000 studenata diplomiralo na UNSA
- 3,000 doktoriralo na UNSA
- Uposleno 2,700 akademskog osoblja
- 800 ostalih zaposlenika
- u prvih 8% svih rangiranih univerziteta u svijetu





UNIVERZITET SARAJEVO

Erasmus+, Erasmus Mundus, Ceepus,
Mevlana, Visegrad FUND,
DAAD, Fulbright...

150 sporazuma o saradnji sa
prestižnim univerzitetima diljem
cijelog svijeta.

područja humanističkih, društvenih,
medicinskih, prirodno-matematičkih i
biotehničkih te tehničkih nauka i
umjetnost.



25 fakulteta i akademija, kao
punopravnih članica Univerziteta,
pet instituta, tri univerzitetska
centra, pet pridruženih članica, te
pet ostalih članica.



GRAĐEVINSKI FAKULTET

- Osnovan 1949.
- Tri ciklusa studiranja
- 80 uposlenika
- 5630 studenata diplomiralo
- 689 studenata trenutno





GRAĐEVINSKI FAKULTET

GRAĐEVINSKI FAKULTET	Podorganizacione jedinice za nastavnonaučnu, naučnoistraživačku i stručnu djelatnost	ODSJEK ZA KONSTRUKCIJE
		Institut za materijale i konstrukcije
		· Laboratorij za ispitivanje materijala i konstrukcija
		· Laboratorij za građevinsku fiziku
		ODSJEK ZA HIDROTEHNIKU I OKOLIŠNO INŽINJERSTVO
		Institut za hidrotehniku i okolišno inženjerstvo
		· Laboratorij za hidrotehniku i okolišno inženjerstvo
		ODSJEK ZA SAOBRAĆAJNICE
		Institut za saobraćajnice
		· Laboratorij za saobraćajnice
		ODSJEK ZA GEODEZIJU I GEOINFORMATIKU
		Institut za geodeziju i geoinformatiku
		· Laboratorij za geodeziju i geoinformatiku
KATEDRA ZA GEOTEHNIKU I GEOLOŠKO INŽINJERSTVO		
Institut za geotehniku i geološko inženjerstvo		
· Laboratorij za geomehanička ispitivanja		
KATEDRA ZA MATEMATIKU I INFORMATIKU		



IMK (Institut za materijale i konstrukcije)

- Osnovan 1960.
- Ispitivanje materijala (drvo, čelik, beton, te ostali)
- Statičko i dinamičko ispitivanje konstrukcija
- Projektovanje, nadzor, revizije, vještačenja, konsalting...





SARADNJA SA PRIVREDOM

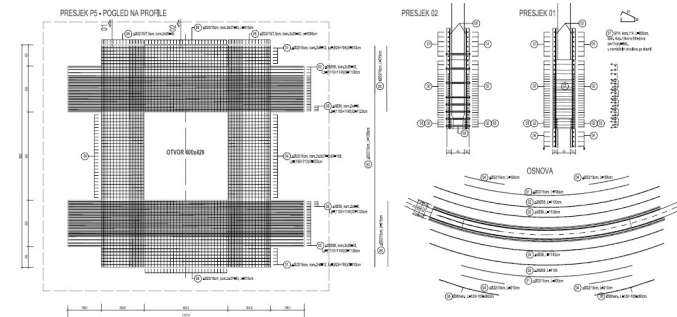
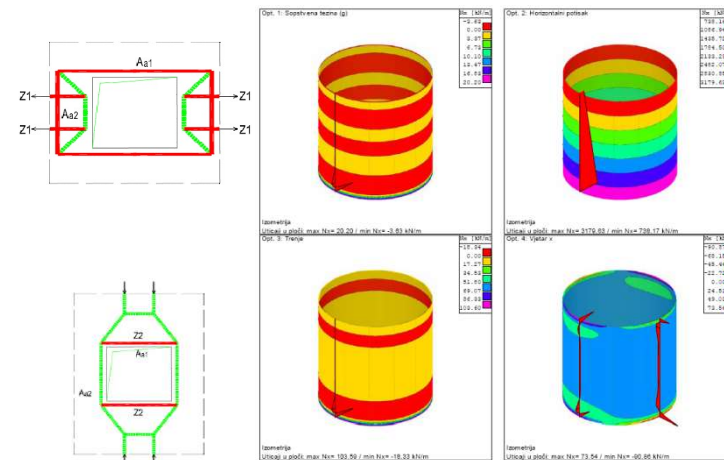
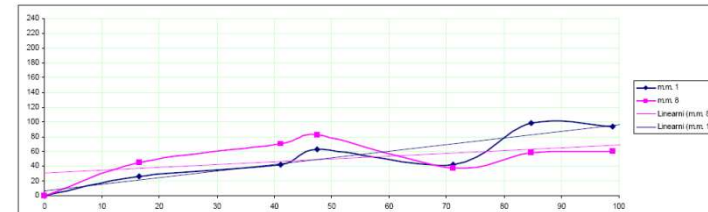



SARADNJA SA PRIVREDOM



**PROMOTING ACADEMIA-INDUSTRY ALLIANCES FOR R&D
THROUGH COLLABORATIVE AND OPEN INNOVATION PLATFORM**
All4R&D

Co-funded by the
Erasmus+ Programme
of the European Union



SARADNJA SA PRIVREDOM





SARADNJA SA PRIVREDOM

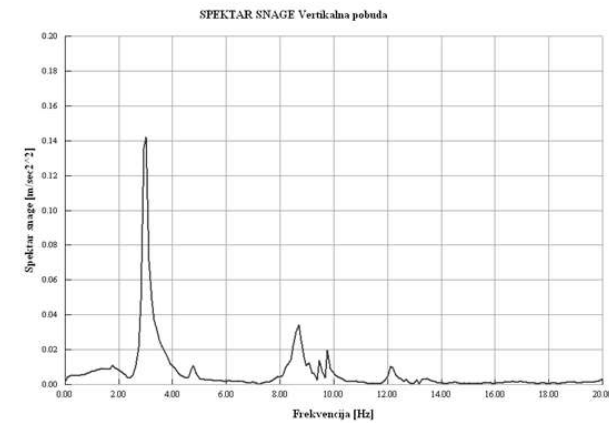
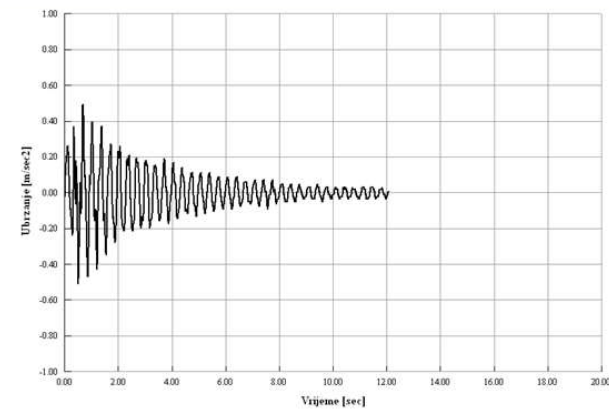

**PROMOTING ACADEMIA-INDUSTRY ALLIANCES FOR R&D
THROUGH COLLABORATIVE AND OPEN INNOVATION PLATFORM**
All4R&D

Co-funded by the
Erasmus+ Programme
of the European Union



SARADNJA SA PRIVREDOM

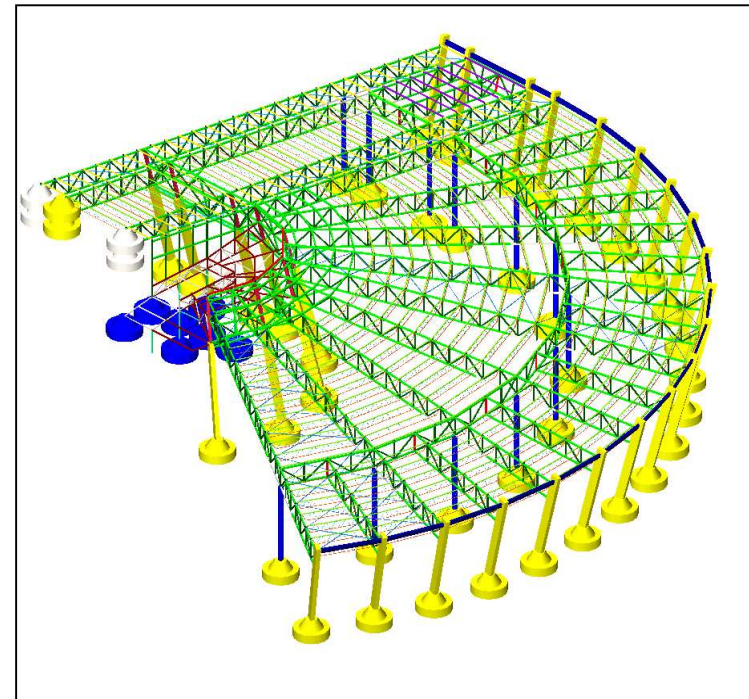



SARADNJA SA PRIVREDOM

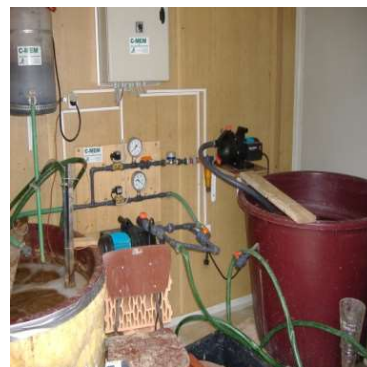



SARADNJA SA PRIVREDOM





SARADNJA SA PRIVREDOM





SARADNJA SA PRIVREDOM





NAUČNO-ISTRAŽIVAČKI RAD





NAUČNO-ISTRAŽIVAČKI RAD

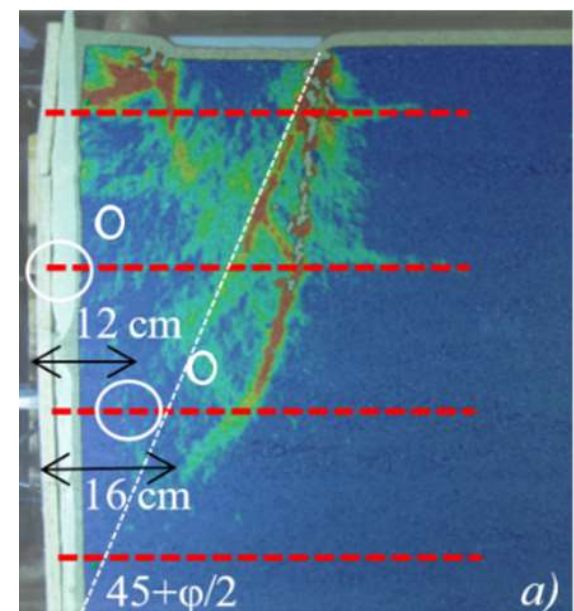



OPREMA ERASMUS+

- Ambijentalne vibracije
- Ostala oprema





LJUDSKI RESURSI

- Profesori i asistenti
- Doktoranti, apsolventi
- Istraživački radnici
- Alumni
- Međunarodna saradnja



PROIZVOĐAČI	PROJEKTANTI	INSTITUCIJE	NAUKA	IZVOBAČI
<ul style="list-style-type: none"> • ARCELOR MITTAL • HEIDELBERGCEMENT • MC - BAUCHEMIE • PERCOM • ROEFIX • TBG BH 	<ul style="list-style-type: none"> • ADS Studio • ARKUS • BP • BPC • CALYPSO • CANBOS • DIVEL • EMNA • EUROENGINEER • FABING • GRUPA ARH • IPSA • STUDIO NONSTOP • STUDIO ZEC • T & E • TRASA 	<ul style="list-style-type: none"> • CESTE FBiH • FEDERALNO MINISTARSTVO PROSTORNOG UREĐENJA • INSTITUT ZA STANDARDIZACIJU • MINISTARSTVO PROSTORNOG UREĐENJA, GRAĐENJA I ZAŠTITE OKOLIŠA KS • UNDPBiH • VANJSKOTRGOVINSKA KOMORA • ZAVOD ZA IZGRADNJU KANTONA SARAJEVO • ZAVOD ZA PLANIRANJE RAZVOJA KANTONA SARAJEVO 	<ul style="list-style-type: none"> • UNMO • UNSA • PTF Zenica 	<ul style="list-style-type: none"> • ANS Drive • BUTMIR • DZEKOS • EUROASFALT • OSDIN • ROLLING • TERMOBETON • VELBOS



PRAVCI SARADNJE

- Studenti (praksa, stipendije, radovi, zaposlenje)
- Doktorati (povezani sa privredom)
- Istraživačke djelatnosti (sve vrste)
- Alumni (usavršavanje)
- Međunarodna saradnja (razmjena znanja i ljudi)



DISKUSIJA

- Predstavljanje učesnika sastanka
- Vaše viđenje moguće saradnje
- Razmjena ideja

