



ASNET-AM

**Academic Scientific Research
Computer Network of Armenia**



Basic Data

- The Academic Scientific Research Computer Network of Armenia (ASNET-AM) is the **National Research and Education Network (NREN)** of Armenia.
- Created in **1994**. The structure and policy of operation was developed and implemented by the **IIAP NAS RA**
- **ASNET-AM** functions as a joint structure of several networking centers and departments within the **IIAP NAS RA**.
-

Basic Data

- Provides various networking solutions to the Academic, Scientific, Research, Educational, Cultural and other organizations of Armenia, which are engaged in scientific and educational activity.
- ASNET-AM develops of Clustering technologies and Scientific GRID infrastructure in Armenia.
- **ASNET-AM** supports of **Armenia-GÉANT** Link

Topology

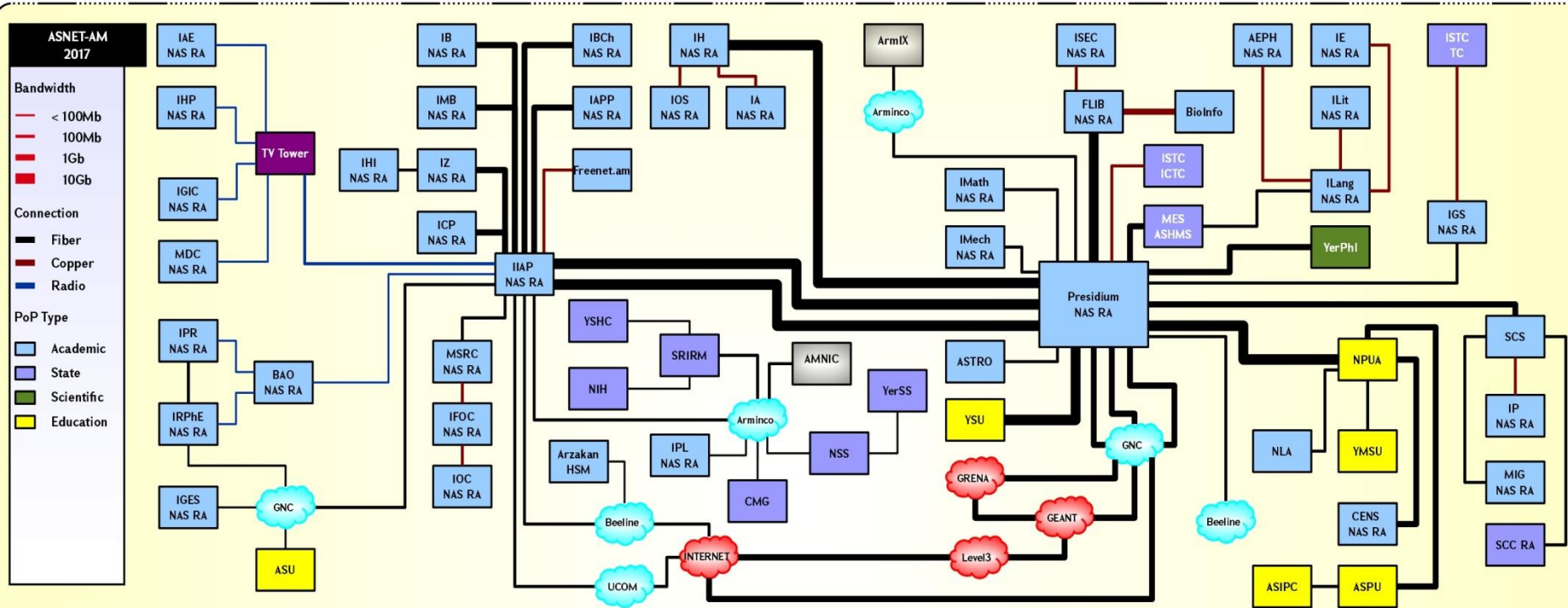

- Presidium of NAS RA
- IMath NAS RA - Institute of Mathematics
- IMech NAS RA - Institute of Mechanics
- IAPP NAS RA - Institute for Informatics and Automation Problems
- BAO NAS RA - Byurakan Astrophysical Observatory
- IRPhE NAS RA - Institute of Radiophysics & Electronics
- IAP NAS RA - Institute of Applied Problems of Physics
- IPR NAS RA - Institute for Physical Research
- CENS NAS RA - Center for Ecological Noosphere Studies
- IBCh NAS RA - Institute of Biochemistry
- IB NAS RA - Institute of Botany
- IHP NAS RA - G.S.Davtyan Institute of Hydroponics Problems
- MDC NAS RA - Microbial Depository Center
- IMB NAS RA - Institute of Molecular Biology
- IP NAS RA - Institute of Physiology
- IZ NAS RA - Institute of Zoology
- IHI NAS RA - Institute of Hydroecology and Ichthyology

- IFOC NAS RA - Institute of Fine Organic Chemistry of Scientific
- IOC NAS RA - Institute of Organic Chemistry of Scientific
- MSRC NAS RA - Molecular Structure Research Center of Scientific
- ICP NAS RA - Institute of Chemical Physics
- IGIC NAS RA - Institute of General and Inorganic Chemistry
- IGS NAS RA - Institute of Geological Sciences
- ISEC NAS RA - Institute of Geophysics and Engineering Seismology
- IH NAS RA - Institute of History
- IPL NAS RA - Institute of Philosophy and Law
- IE NAS RA - Institute of Economics
- IAE NAS RA - Institute of Archaeology and Ethnography
- IOS NAS RA - Institute of Oriental Studies
- ILang NAS RA - Institute of Language
- ILit NAS RA - Institute of Literature
- IA NAS RA - Institute of Art
- MIG NAS RA - Museum-Institute of Genocide
- AEPH NAS RA - Armenian Encyclopaedia Publishing House

- NSS - National Statistical Service
- Arzakan HSM - House of Scientific Meetings "Arzakan"
- ASU - Artsakh State University
- Freenet.am - Armenian Freenet
- CMG - Center of Medical Genetics and Primary Health Care
- SRIRM - Scientific Research Institute of Radio Measurements
- ISEC NAS RA - International Scientific-Educational Center
- BioInfo - Biolinformatics Center
- FLIB NAS RA - Fundamental Library
- NLA - National Library of Armenia
- YMSU - Yerevan State Medical University
- NPUA - National Polytechnic University of Armenia
- ASPU - Armenian State Pedagogical University
- ASIPC - Armenian State Institute of Physical Culture

- YSU - Yerevan State University
- SCS - State Committee of Science
- ISTC TC - ISTC Training Center
- ISTC ICTC - ISTC ICT Center
- MES ASHMS - Ministry of Emergency Situations Armenian State Hydrometeorological and Monitoring Service
- YerPhi - Yerevan Physics Institute
- ASTRO - Regional Center for Relativistic Astrophysics Research
- ArmIX - Armenian Internet Traffic Exchange Foundation
- AMNIC - AM Network Information Center
- YMSU - Yerevan State Medical University
- ASPU - Armenian State Pedagogical University
- GEANT - pan-European data network for the research and education community
- YSHC - Yerevan State Humanitarian College
- NIH - National Institute of Health

Collaboration: Projects



- **GÉANT Project (GN4-2)** - Accelerating research, driving innovation and enriching education.



- **Eastern Partnership Connect (EaPConnect)** project sets out to create a regional high-speed internet network dedicated to research and education (R&E) across Armenia, Azerbaijan, Belarus, Georgia, Moldova and Ukraine.



HP-SEE

- **High-Performance Computing Infrastructure for South East Europe's Research**

Collaboration: Membership



- GÉANT Association is Europe's leading collaboration on e-infrastructure and services for research and education.



- EGI.eu is a not-for-profit foundation to coordinate and manage the European Grid Infrastructure (EGI) federation on behalf of its participants: NGIs and European International Research Organizations.



- CEENET (Central and Eastern European Network) is a private association of Connecticut professionals interested in fostering stronger ties between Connecticut and Central and Eastern Europe.



- ISOC AM (Internet Society) is a non-for-profit NGO of the Local Internet Community in Armenia.



- Regional Internet Registry for Europe, the Middle East and parts of Central Asia

eduroam/eduGAIN

Global WiFi Roaming for Science, Research & Education.



eduPKI

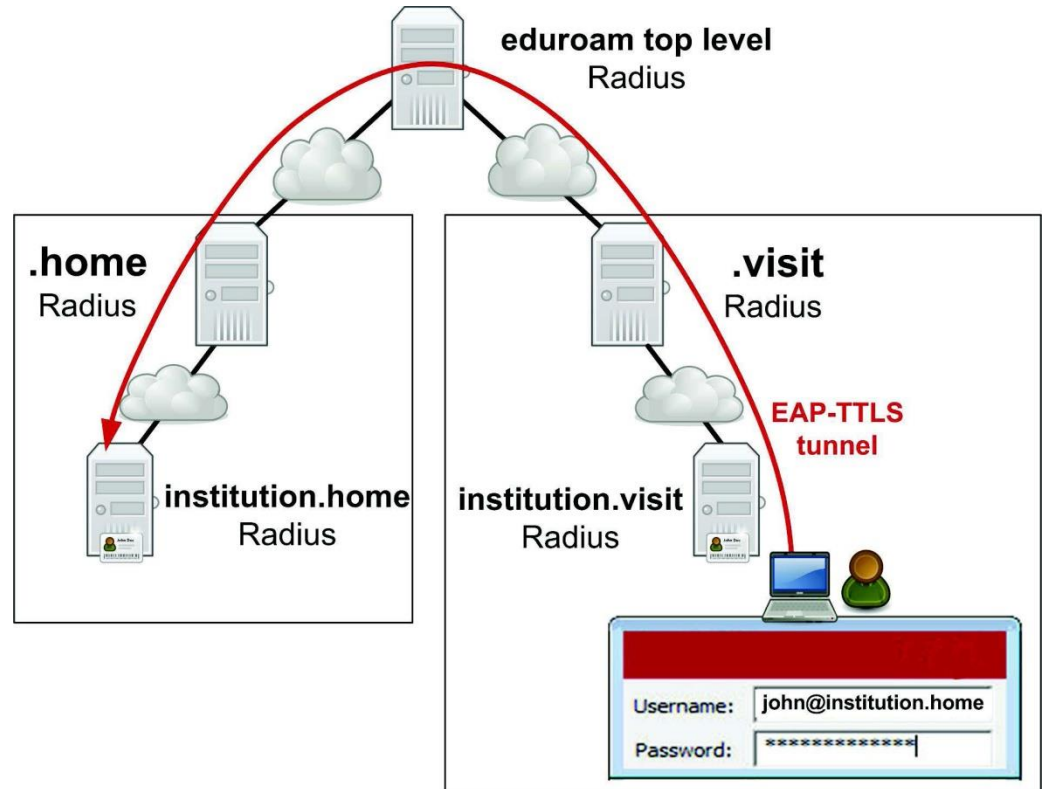

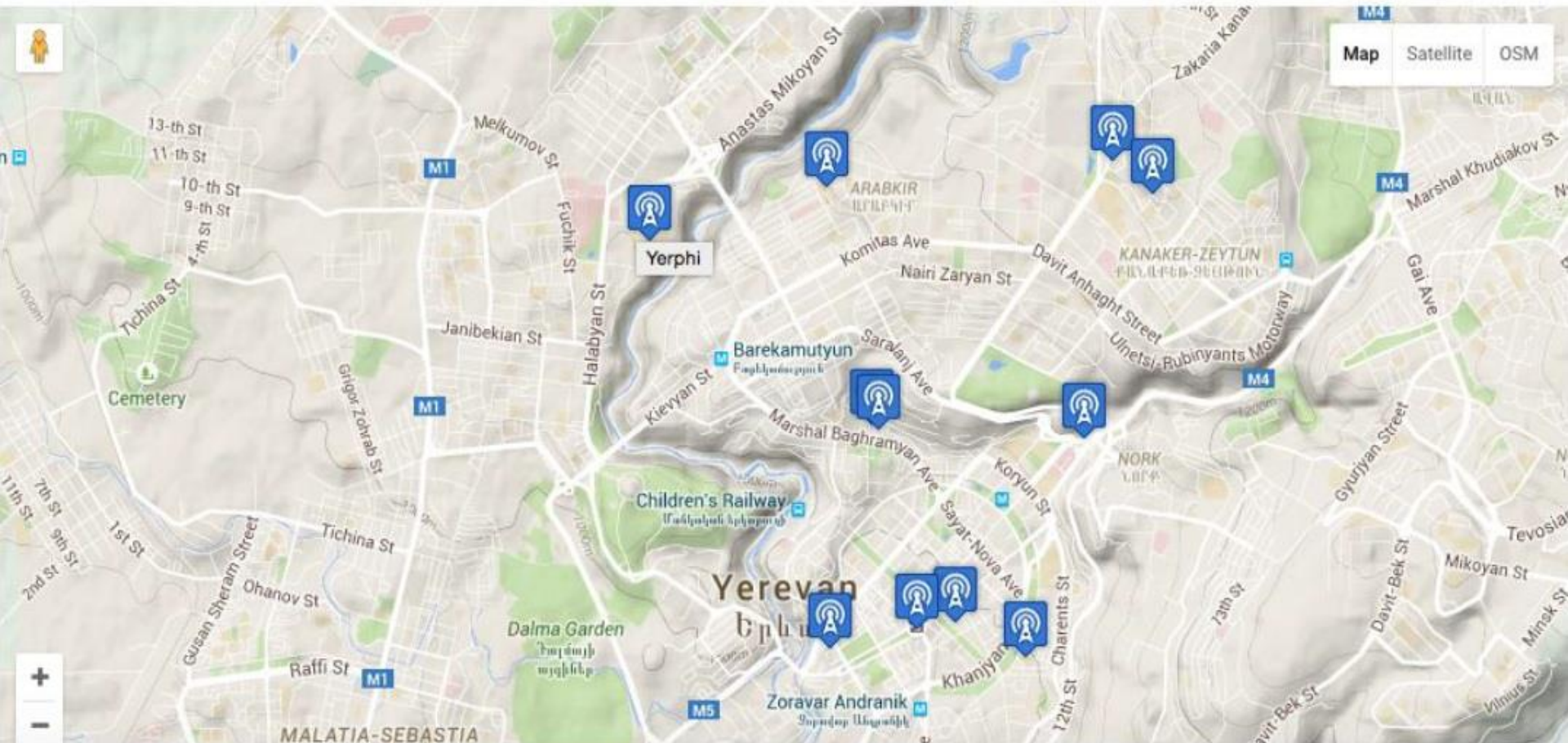

eduroam.am

Filesender

Secure way to share large files with anyone



secure way to share large files with anyone

HELP

ABOUT

1.6 HTML 5 ✓

Welcome to FILESENDER.ASNET.AM

FILESENDER.ASNET.AM is a secure way to share large files with anyone! Logon to upload your files or invite people to send you a file.

LOGON →

ASNET-AM: Drive Service



ASNET Drive

'ASNET Drive' service is a perfect solution for users and organizations



ASNET-AM *Drive*

if

a **secure storage** for its data!

Drive Benefits In Use

- **Performance:** uploads and downloads take place directly over the ASNET-AM network.
- **Support:** Technical support and prompt feedback.
- **High availability:** ASNET-AM backbone provides at least 1Gbit/s secure and physically separated connectivity.
- **Cost-effectiveness:** No extra cost for using the network and service.



Drive Offers

Environment for backup

- to secure the data in case of own storage breakdown.

Environment for archiving

- to store volumes of data that are not accessed very often.

Environment for data sharing

- to share data among distributed user groups.

Data storage for special applications

- to have access to the cloud and high performance computing resources
- to have access to data analytics resources

Video Conference

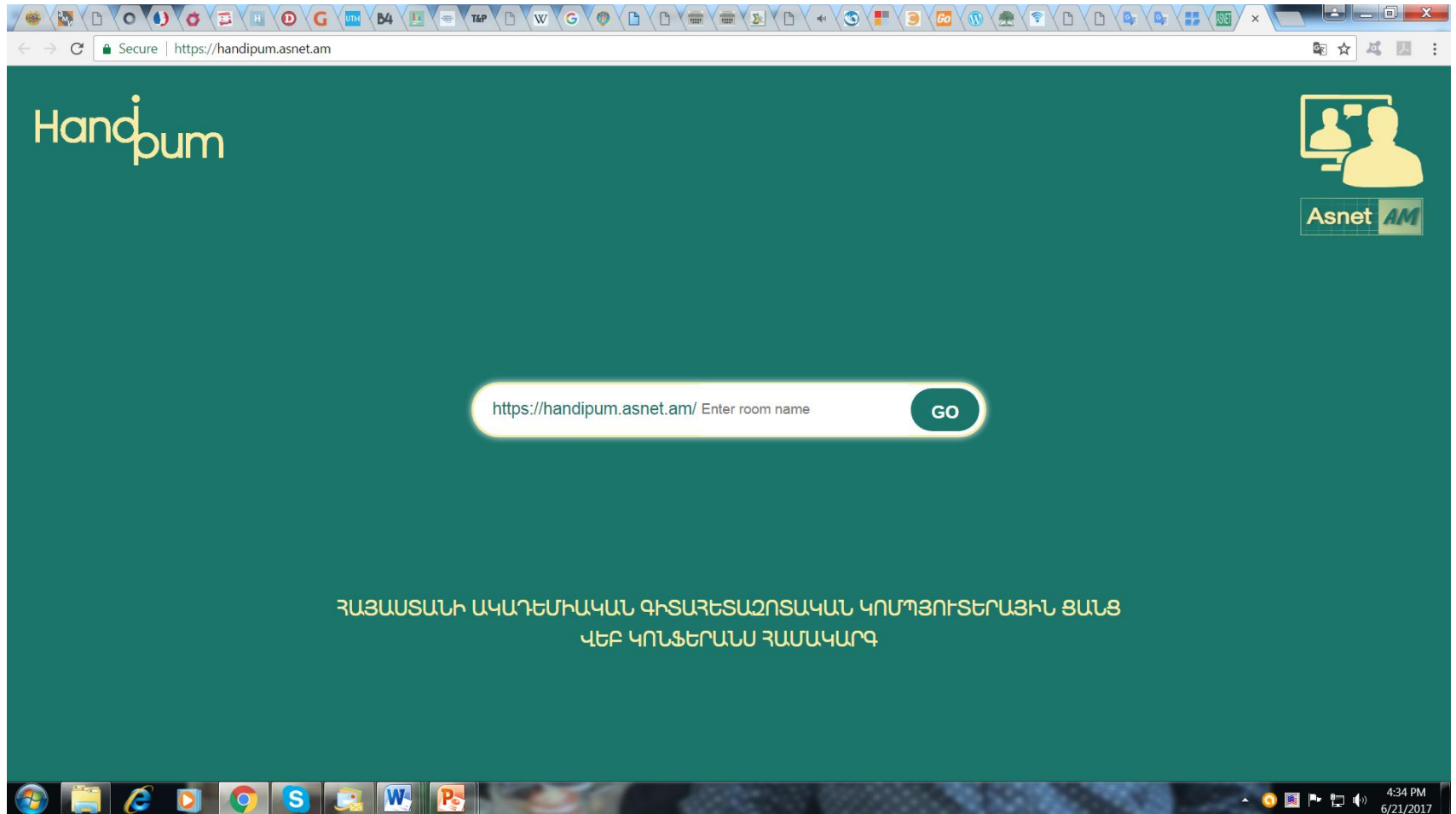

handipum.asnet.am

Video Conference

ASNET-AM Web Conferencing Service allows to operate Browser-based Web RTC Conferences.

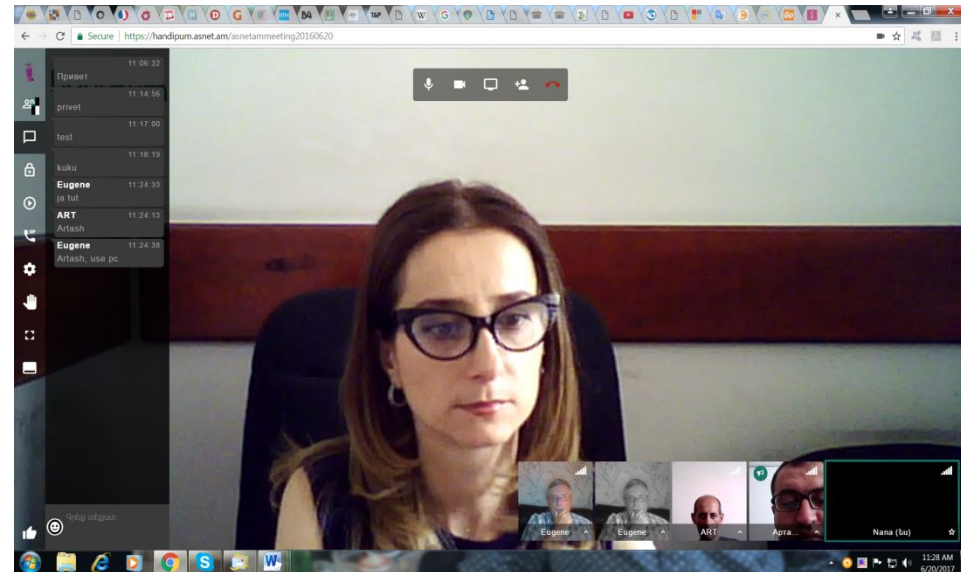

handipum.asnet.am

ASNET-AM VoIP Service

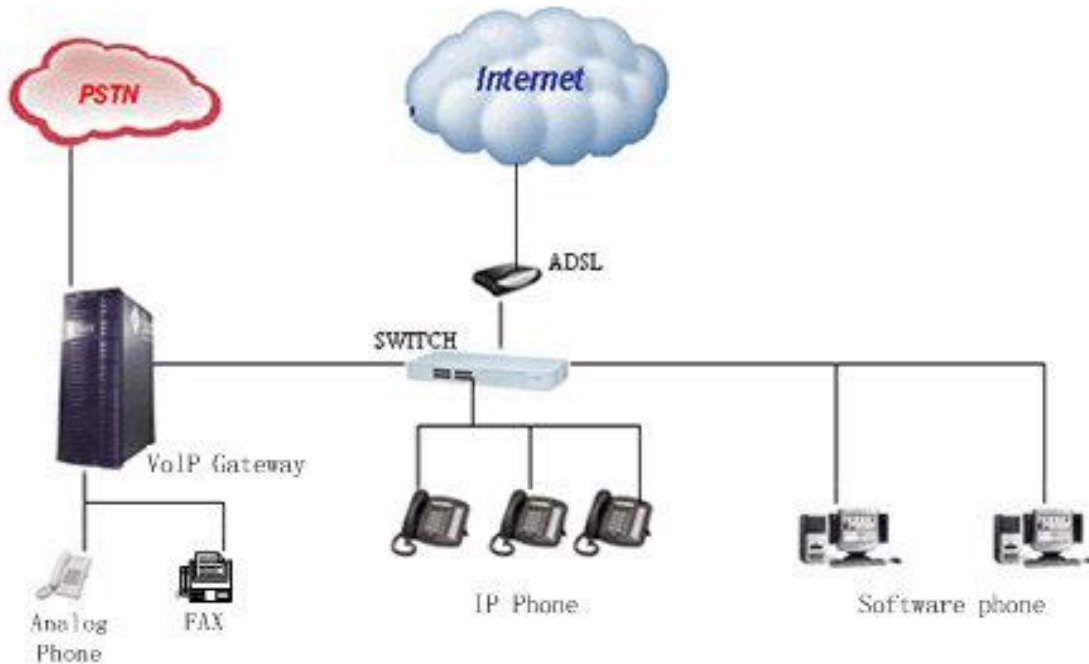

- Possibility to connect all academician Institutions
- Possibility to use as standard Phones also IP Phones
- Possibility make Internal and outgoing calls

Streaming



webconf.asnet.am

Online education and research



afire.asnet.am

IP Connectivity

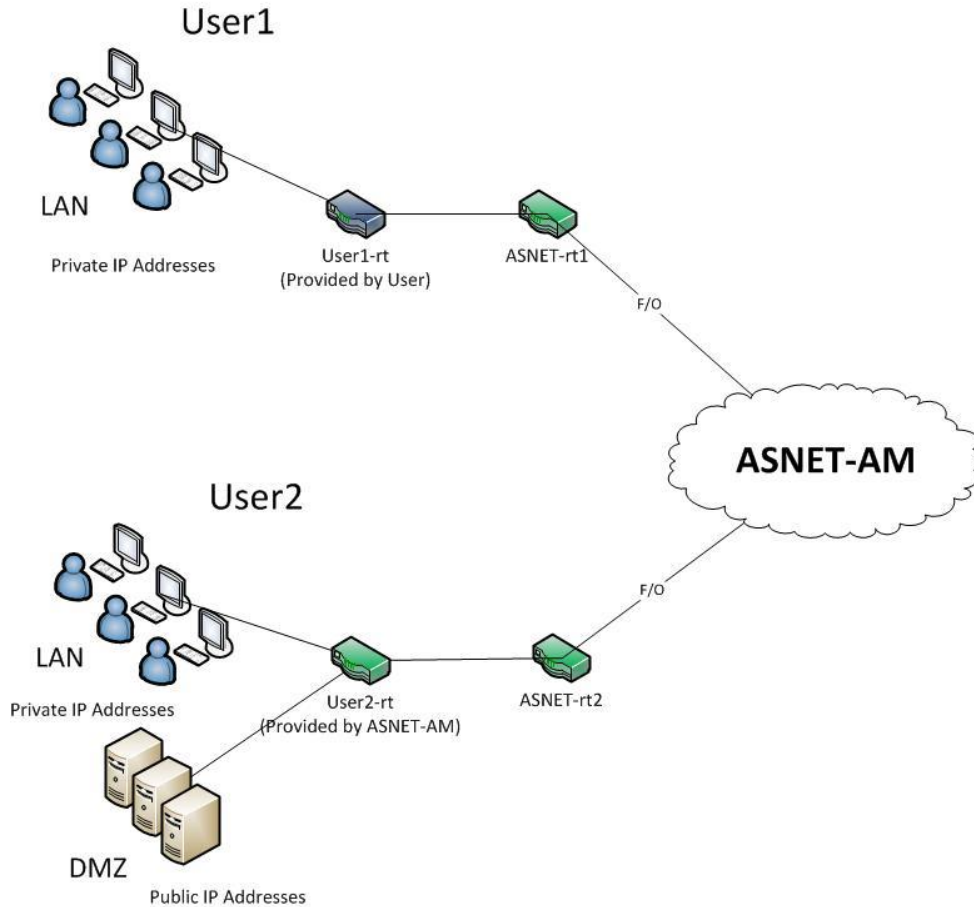

ASNET-AM can provide our users with wide range of Public IP addresses from 1 to 128 and Private IP addresses *unlimited*.

ASNET-AM can provide port on our router as *gateway* for our users LAN Private IP addresses. NAT, DHCP and Proxy service can be provided if needed.

Other configurations are also possible.

Armenian Federation Identity for Research and Education

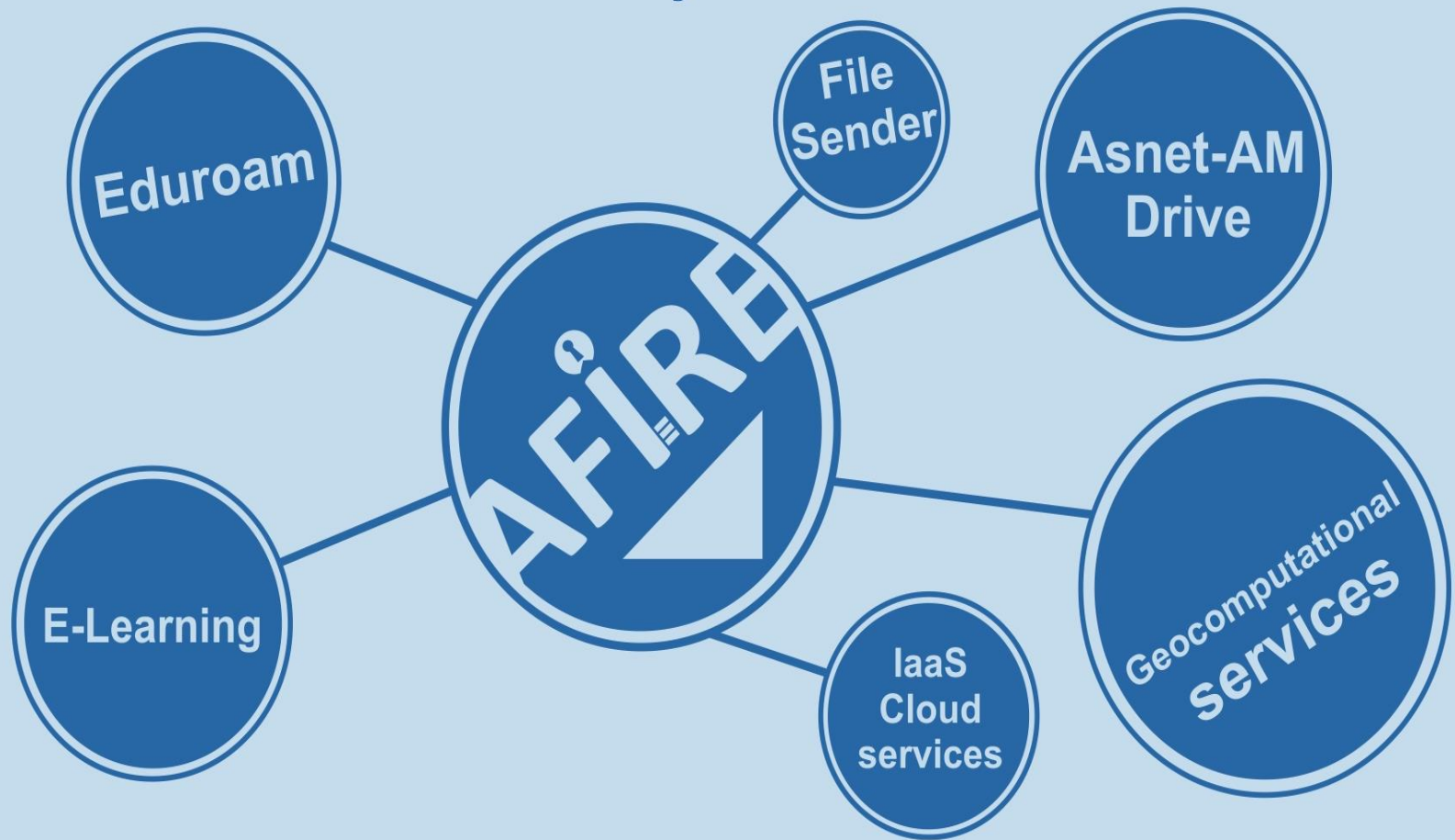

afire.asnet.am

Armenian Federated Identity

To register:

<https://afire.asnet.am/index.php/registration>

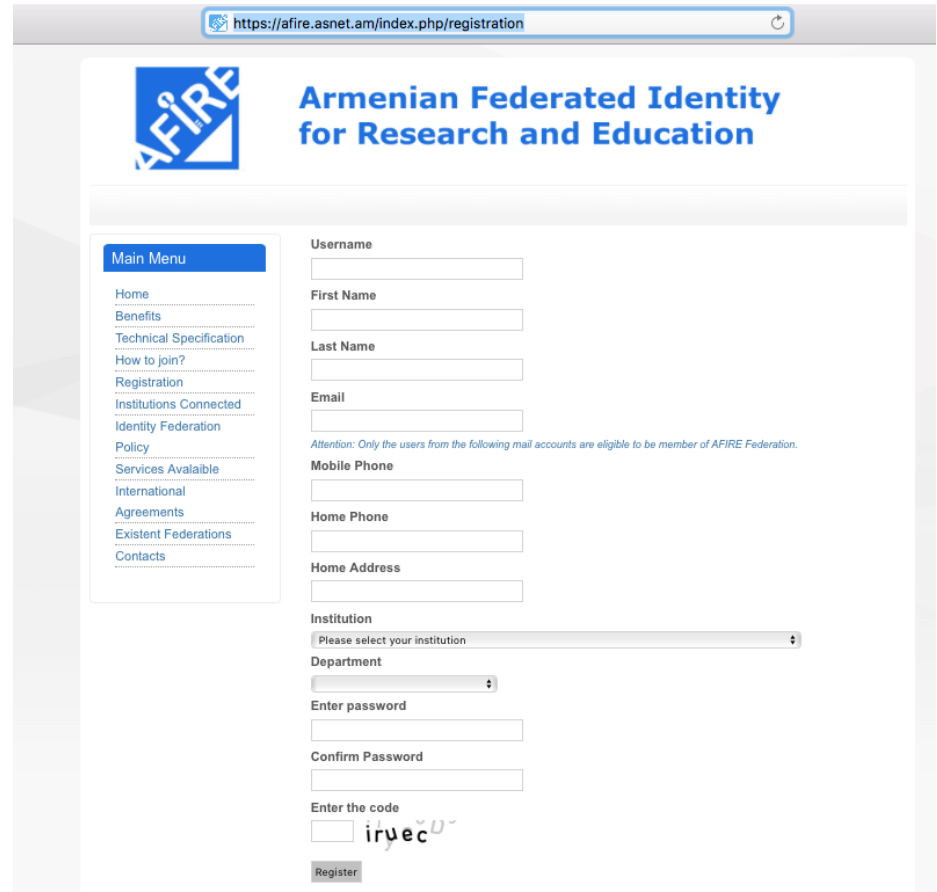

The screenshot shows a web browser window with the URL <https://afire.asnet.am/index.php/registration>. The page features the AFIRE logo and the title "Armenian Federated Identity for Research and Education". On the left, there is a "Main Menu" with links to Home, Benefits, Technical Specification, How to join?, Registration, Institutions Connected, Identity Federation, Policy, Services Available, International, Agreements, Existent Federations, and Contacts. The registration form on the right includes fields for Username, First Name, Last Name, Email, Mobile Phone, Home Phone, Home Address, Institution (a dropdown menu), Department (a dropdown menu), Enter password, Confirm Password, and Enter the code (with a CAPTCHA image). A "Register" button is located at the bottom of the form. A small note below the Email field states: "Attention: Only the users from the following mail accounts are eligible to be member of AFIRE Federation."

Available resources

- [ajm.asj-oa.am](#)
 - [ajp.asj-oa.am](#)
 - [astro.asj-oa.am](#)
 - [baas.asj-oa.am](#)
 - [basns.asj-oa.am](#)
 - [basss.asj-oa.am](#)
 - [bc.asj-oa.am](#)
 - [biology.asj-oa.am](#)
 - [chemistry.asj-oa.am](#)
 - [earth.asj-oa.am](#)
 - [elib.sci.am](#)
 - [etd.asj-oa.am](#)
 - [hpj.asj-oa.am](#)
 - [irphe.asj-oa.am](#)
 - [lraber.asj-oa.am](#)
 - [mathematics.asj-oa.am](#)
 - [mechanics.asj-oa.am](#)
 - [medsci.asj-oa.am](#)
 - [physics.asj-oa.am](#)
- pubs.asnet.am**

THANK YOU